



Ex

2.12

**Products for
Explosion hazardous Environment**

Non-electric valves for explosion hazardous environment

The following **manually and mechanically actuated valves** are available for the use in explosion hazardous environment in zones 1, 2, 21, 22 gas and dust:

Type	Function	Port size	Further inform. on valve on page
BV 311 301 EX	3/2-way, stem actuated	G 1/8"	2.1.1.4
BV 511 301 EX	5/2-way, stem actuated	G 1/8"	2.1.2.2
BA 311 301 EX	3/2-way, for panel mounting	G 1/8"	2.2.1
BA 511 301 EX	5/2-way, for panel mounting	G 1/8"	2.2.2
BA 22_	Actuator elements		2.2.3



The products are marked:

II2G/D c T6 -10° C ≤ Ta ≤ 50° C

Delivery contains a manual as well as a declaration of conformity.

A declaration of the manufacturer that the actuation elements BA 22_ do not require a certification can be supplied on request. For the use in dust atmosphere we recommend the use of a dust protection cap.

The following **pneumatically actuated valves** are available for the use in explosion hazardous environment in zone zone 1, 2, 21, 22 gas and dust:

Type	Function	Port size	Further information on valve on page		
			Aluminum	Low Temp.	Stainl. Steel
P 310 502 EX	3/2-way, single sol.	G 1/8"	2.4.1.1		
P 310 501 EX	3/2-way, single sol.	G 1/8"	2.4.1.2	2.9.3.1	
P 310 701 EX	3/2-way, single sol.	G 1/4" - 1/4" NPT	2.4.1.2	2.9.3.1	2.10.2.1
P 310 801 EX	3/2-way, single sol.	G 1/4"	2.4.1.2		
P 310 101 EX	3/2-way, single sol.	G 3/8"	2.4.1.3		
P 310 121 EX	3/2-way, single sol.	G 1/2" - 1/2" NPT	2.4.1.3		2.10.2.1
P 320 502 EX	3/2-way, double sol.	G 1/8"	2.4.1.5		
P 320 501 EX	3/2-way, double sol.	G 1/8"	2.4.1.6	2.9.3.1	
P 320 701 EX	3/2-way, double sol.	G 1/4" - 1/4" NPT	2.4.1.6	2.9.3.1	
P 320 801 EX	3/2-way, double sol.	G 1/4"	2.4.1.6		
P 320 101 EX	3/2-way, double sol.	G 3/8"	2.4.1.7		
P 320 121 EX	3/2-way, double sol.	G 1/2" - 1/2" NPT	2.4.1.7		
P 510 502 EX	5/2-way, single sol.	G 1/8"	2.4.2.1		
P 510 501 EX	5/2-way, single sol.	G 1/8"	2.4.2.2	2.9.3.2	
P 510 701 EX	5/2-way, single sol.	G 1/4" - 1/4" NPT	2.4.2.2	2.9.3.2	2.10.2.2
P 510 801 EX	5/2-way, single sol.	G 1/4"	2.4.2.2		
P 510 101 EX	5/2-way, single sol.	G 3/8"	2.4.2.3		
P 510 121 EX	5/2-way, single sol.	G 1/2" - 1/2" NPT	2.4.2.3		2.10.2.2
P 520 502 EX	5/2-way, double sol.	G 1/8"	2.4.2.5		
P 520 501 EX	5/2-way, double sol.	G 1/8"	2.4.2.6	2.9.3.2	
P 520 701 EX	5/2-way, double sol.	G 1/4" - 1/4" NPT	2.4.2.6	2.9.3.2	2.10.2.3
P 520 801 EX	5/2-way, double sol.	G 1/4"	2.4.2.6		
P 520 101 EX	5/2-way, double sol.	G 3/8"	2.4.2.7		
P 520 121 EX	5/2-way, double sol.	G 1/2" - 1/2" NPT	2.4.2.7		2.10.2.3
P 531 501 EX	5/3-way, centre closed	G 1/8"	2.4.3.1	2.9.3.3	
P 531 701 EX	5/3-way, centre closed	G 1/4" - 1/4" NPT	2.4.3.1	2.9.3.3	2.10.2.3
P 531 801 EX	5/3-way, centre closed	G 1/4"	2.4.3.1		
P 531 101 EX	5/3-way, centre closed	G 3/8"	2.4.3.2		
P 531 121 EX	5/3-way, centre closed	G 1/2" - 1/2" NPT	2.4.3.2		2.10.2.3
P 532 501 EX	5/3-way, centre exhausted	G 1/8"	2.4.3.1	2.9.3.3	
P 532 701 EX	5/3-way, centre exhausted	G 1/4" - 1/4" NPT	2.4.3.1	2.9.3.3	2.10.2.3
P 532 801 EX	5/3-way, centre exhausted	G 1/4"	2.4.3.1		
P 532 101 EX	5/3-way, centre exhausted	G 3/8"	2.4.3.2		
P 532 121 EX	5/3-way, centre exhausted	G 1/2" - 1/2" NPT	2.4.3.2		2.10.2.3
P 533 501 EX	5/3-way, centre pressurised	G 1/8"	2.4.3.1	2.9.3.3	
P 533 701 EX	5/3-way, centre pressurised	G 1/4" - 1/4" NPT	2.4.3.1	2.9.3.3	2.10.2.3
P 533 801 EX	5/3-way, centre pressurised	G 1/4"	2.4.3.1		
P 533 101 EX	5/3-way, centre pressurised	G 3/8"	2.4.3.2		
P 533 121 EX	5/3-way, centre pressurised	G 1/2" - 1/2" NPT	2.4.3.2		2.10.2.3

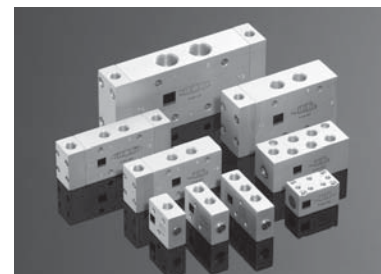

The products are marked:

II2G/D c T6 -10° C ≤ Ta ≤ 50° C

Delivery contains a manual as well as a declaration of conformity.

ATEX-certified pneumatically actuated valves for low-temperature applications as well as stainless steel products are available on request.

Solenoid valves for explosion hazardous environment – General order information

Overview of available solenoid systems for explosion hazardous environment

Zone	Temp. range	Ignition protection type	Temp. class	Connection	Valve		
					Aluminum	Stainless Steel	Solenoid Steel
1, 2, 21, 22	-10°C ... +50°C	Ex m	T4	3 meter cable (other lengths on request)	2.12.2.1.1	2.12.2.1.2	2.12.2.1.3
1, 2, 21, 22	-10°C ... +50°C	Ex ia	T6	Connector A, ISO 4400	2.12.2.2.1	2.12.2.2.3	2.12.2.2.5
1, 2, 21, 22	-40°C ... +50°C	Ex ia	T6	Connector A, ISO 4400	2.12.2.2.2	2.12.2.2.4	2.12.2.2.5
2, 22	-10°C ... +50°C	Ex nA	T5	Connector B, Industrial	2.12.2.3.1	2.12.2.3.2	2.12.2.3.3
1, 2, 21, 22	-10°C ... +50°C	Ex e mb	T6	Junction box to connect cables with dia. 6 – 13 mm	2.12.2.4.1		2.12.2.4.4
1, 2, 21, 22	-40°C ... +50°C	Ex e mb	T6	Junction box to connect cables with dia. 6 – 13 mm	2.12.2.4.2	2.12.2.4.3	2.12.2.4.4

Types of ignition protection

For solenoids: **m** = Encapsulation
ia = Intrinsically safe
nA = Non-incentive component
e mb = Encapsulation enhanced, normally with junction box.

For valves: **c** = safety based on construction.

Important for ignition protection type **ia** is that it is only to be used in combination with a certified intrinsically safe electrical circuit.

Temperature class

Temperature class	Maximum permitted surface temperature of equipment
T1	450°C
T2	300°C
T3	200°C
T4	135°C
T5	100°C
T6	85°C

Zones and categories

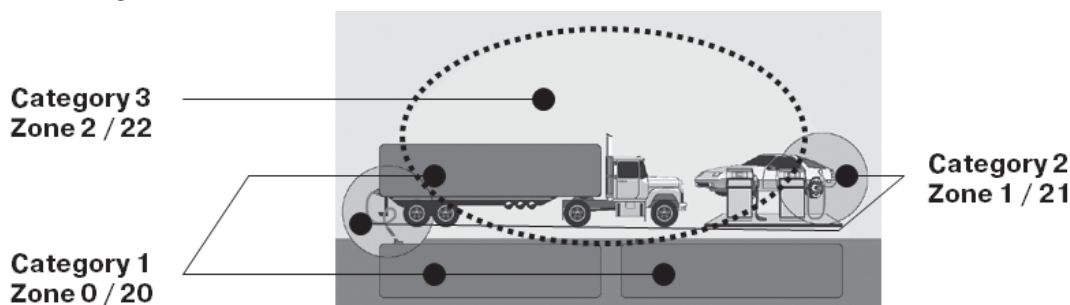

Zone 1 = category 2 for Gas
 Zone 21 = category 2 for Dust
 Zone 2 = category for Gas
 Zone 22 = category for Dust

Zone 1 includes zone 2, zone 21 includes zone 22.

ATEX-approved valves – Ex m – standard temperature range – aluminum



Material: Aluminum, anodized
 Zone: 1, 2, 21, 22
 Temperature range: -10°C ... +50°C
 Ignition protection type: Ex m (encapsulation)
 Temperature class: T4

Marking on valve Ex II2G/D c T4 -10° C ≤ Ta ≤ 50° C
 II3G/D c T5 -10° C ≤ Ta ≤ 50° C

A low temperature version for -20°C ... +50°C is also available on request. Please notice that the system is restricted by the minimum ambiente temperature for the coil of -20°C.

The following **solenoid valves** are available:

Type	Function	Port size	Installation	Further information on valve on page
MH 210 501 Ex m	2/2-way, single sol.	G 1/8"	in-line	2.5.1.1.11
MH 210 701 Ex m	2/2-way, single sol.	G 1/4"	in-line	2.5.1.1.11
MH 311 012 Ex m	3/2-way direct acting	M5	in-line	2.5.1.1.2
MH 311 015 Ex m	3/2-way direct acting	G 1/8"	in-line	2.5.1.1.2
MH 311 013 Ex m	3/2-way direct acting	G 1/8"	banjo screw	2.5.1.1.4
MH 311 017 Ex m	3/2-way direct acting	G 1/4"	banjo screw	2.5.1.1.4
MH 312 Ex m	3/2-way direct acting	M5	manifold	2.5.1.2.2
MH 315 Ex m	3/2-way direct acting	G 1/8"	manifold	2.5.1.2.2
MH 310 501 Ex m	3/2-way, single sol.	G 1/8"	in-line	2.5.1.1.12
MOH 310 501 Ex m	3/2-way, n.o. single sol.	G 1/8"	in-line	2.5.1.1.12
MH 310 701 Ex m	3/2-way, single sol.	G 1/4"	in-line	2.5.1.1.12
MOH 310 701 Ex m	3/2-way, n.o. single sol.	G 1/4"	in-line	2.5.1.1.12
MH 310 801 Ex m	3/2-way, single sol.	G 1/4"	in-line	2.5.1.1.12
MOH 310 801 Ex m	3/2-way, n.o. single sol.	G 1/4"	in-line	2.5.1.1.12
MH 310 101 Ex m	3/2-way, single sol.	G 3/8"	in-line	2.5.1.1.13
MOH 310 101 Ex m	3/2-way, n.o. single sol.	G 3/8"	in-line	2.5.1.1.13
MH 310 121 Ex m	3/2-way, single sol.	G 1/2" - 1/2" NPT	in-line	2.5.1.1.13
MOH 310 121 Ex m	3/2-way, n.o. single sol.	G 1/2" - 1/2" NPT	in-line	2.5.1.1.13
MH 310 501 G Ex m	3/2-way, single sol.	G 1/8"	dual use*	2.5.1.1.14
MOH 310 501 G Ex m	3/2-way, n.o. single sol.	G 1/8"	dual use*	2.5.1.1.14
MH 310 701 G Ex m	3/2-way, single sol.	G 1/4" - 1/4" NPT	dual use*	2.5.1.1.14
MOH 310 701 G Ex m	3/2-way, n.o. single sol.	G 1/4" - 1/4" NPT	dual use*	2.5.1.1.14
MH 310 101 G Ex m	3/2-way, single sol.	G 3/8"	dual use*	2.5.1.1.15
MOH 310 101 G Ex m	3/2-way, n.o. single sol.	G 3/8"	dual use*	2.5.1.1.15
MH 310 121 G Ex m	3/2-way, single sol.	G 1/2"	dual use*	2.5.1.1.15
MOH 310 121 G Ex m	3/2-way, n.o. single sol.	G 1/2"	dual use*	2.5.1.1.15

ATEX-approved valves – Ex m – standard temperature range – aluminum

Type	Function	Port size	Installation	Further information on valve on page
MH 320 501 Ex m	3/2-way, double sol.	G 1/8"	in-line	2.5.1.1.6
MH 320 701 Ex m	3/2-way, double sol.	G 1/4"	in-line	2.5.1.1.6
MH 320 801 Ex m	3/2-way, double sol.	G 1/4"	in-line	2.5.1.1.6
MH 320 101 Ex m	3/2-way, double sol.	G 3/8"	in-line	2.5.1.1.7
MH 320 121 Ex m	3/2-way, double sol.	G 1/2"	in-line	2.5.1.1.7
MH 320 501 G Ex m	3/2-way, double sol.	G 1/8"	dual use*	2.5.1.1.8
MH 320 701 G Ex m	3/2-way, double sol.	G 1/4"	dual use*	2.5.1.1.8
MH 320 101 G Ex m	3/2-way, double sol.	G 3/8"	dual use*	2.5.1.1.8
MH 320 121 G Ex m	3/2-way, double sol.	G 1/2"	dual use*	2.5.1.1.8
MH 510 501 Ex m	5/2-way, single sol.	G 1/8"	in-line	2.5.2.1.3
MH 510 701 Ex m	5/2-way, single sol.	G 1/4"	in-line	2.5.2.1.3
MH 510 801 Ex m	5/2-way, single sol.	G 1/4"	in-line	2.5.2.1.3
MH 510 101 Ex m	5/2-way, single sol.	G 3/8"	in-line	2.5.2.1.4
MH 510 121 Ex m	5/2-way, single sol.	G 1/2" - 1/2" NPT	in-line	2.5.2.1.4
MH 510 501 G Ex m	5/2-way, single sol.	G 1/8"	dual use*	2.5.2.1.5
MH 510 701 G Ex m	5/2-way, single sol.	G 1/4" - 1/4" NPT	dual use*	2.5.2.1.5
MH 510 101 G Ex m	5/2-way, single sol.	G 3/8"	dual use*	2.5.2.1.6
MH 510 121 G Ex m	5/2-way, single sol.	G 1/2"	dual use*	2.5.2.1.6
MH 510 504 Ex m	5/2-way, single sol.	5 mm orifice	manifold, all ports in plate	2.5.2.2.4
MH 510 704 Ex m	5/2-way, single sol.	7 mm orifice	manifold, all ports in plate	2.5.2.2.4
MH 520 501 Ex m	5/2-way, double sol.	G 1/8"	in-line	2.5.2.1.9
MH 520 701 Ex m	5/2-way, double sol.	G 1/4"	in-line	2.5.2.1.9
MH 520 801 Ex m	5/2-way, double sol.	G 1/4"	in-line	2.5.2.1.9
MH 520 101 Ex m	5/2-way, double sol.	G 3/8"	in-line	2.5.2.1.10
MH 520 121 Ex m	5/2-way, double sol.	G 1/2" - 1/2" NPT	in-line	2.5.2.1.10
MH 520 501 G Ex m	5/2-way, double sol.	G 1/8"	dual use*	2.5.2.1.11
MH 520 701 G Ex m	5/2-way, double sol.	G 1/4" - 1/4" NPT	dual use*	2.5.2.1.11
MH 520 101 G Ex m	5/2-way, double sol.	G 3/8"	dual use*	2.5.2.1.12
MH 520 121 G Ex m	5/2-way, double sol.	G 1/2"	dual use*	2.5.2.1.12
MH 520 504 Ex m	5/2-way, double sol.	5 mm orifice	manifold, all ports in plate	2.5.2.2.8
MH 520 704 Ex m	5/2-way, double sol.	7 mm orifice	manifold, all ports in plate	2.5.2.2.8
MH 53_ 501 Ex m	5/3-way, different versions	G 1/8"	in-line	2.5.3.1.2
MH 53_ 701 Ex m	5/3-way, different versions	G 1/4"	in-line	2.5.3.1.2
MH 53_ 801 Ex m	5/3-way, different versions	G 1/4"	in-line	2.5.3.1.2
MH 53_ 101 Ex m	5/3-way, different versions	G 3/8"	in-line	2.5.3.1.3
MH 53_ 121 Ex m	5/3-way, different versions	G 1/2" - 1/2" NPT	in-line	2.5.3.1.3
MH 53_ 501 G Ex m	5/3-way, different versions	G 1/8"	dual use*	2.5.3.1.4
MH 53_ 701 G Ex m	5/3-way, different versions	G 1/4" - 1/4" NPT	dual use*	2.5.3.1.4
MH 53_ 101 G Ex m	5/3-way, different versions	G 3/8"	dual use*	2.5.3.1.5
MH 53_ 121 G Ex m	5/3-way, different versions	G 1/2"	dual use*	2.5.3.1.5
MH 53_ 504 Ex m	5/3-way, different versions	5 mm orifice	manifold, all ports in plate	2.5.3.2.4
MH 53_ 704 Ex m	5/3-way, different versions	7 mm orifice	manifold, all ports in plate	2.5.3.2.4

Valves with interface according to Namur standard

MNH 350 701 Ex m	3/2-way & 5/2-way	G 1/4" - 1/4" NPT	1/4" Namur	2.8.1.3
MNH 310 701 Ex m	3/2-way, single sol.	G 1/4" - 1/4" NPT	1/4" Namur	2.8.1.1.1
MNH 310 711 Ex m	3/2-way, single sol.	G 1/4"	1/4" Namur	2.8.1.1.1
MNH 310 121 Ex m	3/2-way, single sol.	G 1/2" - 1/2" NPT	1/2" Namur	2.8.1.1.2
MNH 510 701 Ex m	5/2-way, single sol.	G 1/4" - 1/4" NPT	1/4" Namur	2.8.1.2.1
MNH 510 711 Ex m	5/2-way, single sol.	G 1/4"	1/4" Namur	2.8.1.2.1
MNH 510 121 Ex m	5/2-way, single sol.	G 1/2" - 1/2" NPT	1/2" Namur	2.8.1.2.2
MNH 520 701 Ex m	5/2-way, double sol.	G 1/4" - 1/4" NPT	1/4" Namur	2.8.1.2.3
MNH 520 121 Ex m	5/2-way, double sol.	G 1/2" - 1/2" NPT	1/2" Namur	2.8.1.2.3
MNH 53_ 701 Ex m	5/3-way, different versions	G 1/4" - 1/4" NPT	1/4" Namur	2.8.1.4
MNH 531 121 Ex m	5/3-way, centre closed	G 1/2" - 1/2" NPT	1/2" Namur	2.8.1.4

* dual use valves can either be used in-line or on a manifold plate.

Solenoids are described on page 2.12.2.1.3

Further coils variants on request: CSA / FM certified coils.

Delivery contains valve with the appropriate operator system, coil, manual and declaration of conformity.

ATEX-approved valves – Ex m – standard temperature range – stainless steel

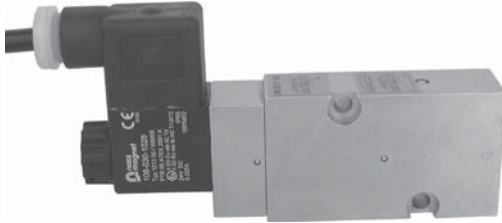

Material: Stainless steel, 316L 
 Zone: 1, 2, 21, 22
 Temperature range: -10°C ... +50°C
 Ignition protection type: Ex m (encapsulation)
 Temperature class: T4

Marking on valve  II2G/D c T4 -10° C ≤ Ta ≤ 50° C
 II3G/D c T5 -10° C ≤ Ta ≤ 50° C

A low temperature version for -20°C ... +50°C is also available on request. Please notice that the system is restricted by the minimum applicable temperature of the coil of -20°C.

The following **solenoid valves** are available:

Type	Function	Port size	Installation	Further information on valve on page
MH 311 015 VES Ex m	3/2-way direct acting	G 1/8"	in-line	2.10.3.1
MH 310 701 VES Ex m	3/2-way, single sol.	G 1/4" - 1/4" NPT	in-line	2.10.3.2
MOH 310 701 VES Ex m	3/2-way, n.o. single sol.	G 1/4" - 1/4" NPT	in-line	2.10.3.2
MH 310 121 VES Ex m	3/2-way, single sol.	G 1/2" - 1/2" NPT	in-line	2.10.3.3
MH 320 121 VES Ex m	3/2-way, double sol.	G 1/2"	in-line	2.10.3.3
MH 510 701 VES Ex m	5/2-way, single sol.	G 1/4" - 1/4" NPT	in-line	2.10.3.4
MH 510 121 VES Ex m	5/2-way, single sol.	G 1/2" - 1/2" NPT	in-line	2.10.3.4
MH 520 701 VES Ex m	5/2-way, double sol.	G 1/4" - 1/4" NPT	in-line	2.10.3.5
MH 520 121 VES Ex m	5/2-way, double sol.	G 1/2" - 1/2" NPT	in-line	2.10.3.5
MH 53_ 701 VES Ex m	5/3-way, different versions	G 1/4" - 1/4" NPT	in-line	2.10.3.6
MH 53_ 121 VES Ex m	5/3-way, different versions	G 1/2" - 1/2" NPT	in-line	2.10.3.6

Valves with interface according to Namur standard

MNH 350 701 VES Ex m	3/2-way & 5/2-way	G 1/4" - 1/4" NPT	1/4" Namur	2.10.4.3
MNH 310 701 VES Ex m	3/2-way, single sol.	G 1/4" - 1/4" NPT	1/4" Namur	2.10.4.1
MNH 510 701 VES Ex m	5/2-way, single sol.	G 1/4" - 1/4" NPT	1/4" Namur	2.10.4.2
MNH 520 701 VES Ex m	5/2-way, double sol.	G 1/4" - 1/4" NPT	1/4" Namur	2.10.4.2

Solenoids are described on page 2.12.2.1.3

Further coils variants on request: CSA / FM certified coils.

Delivery contains valve with the appropriate operator system, coil, manual and declaration of conformity.

When this solenoid system is used in combination with „ATEX certified“ mechanical components conforming EN 13463-1:2001 and PrEN 13463-5:2000, the entire valve can be used in explosive hazardous environment zone 1 and 21.

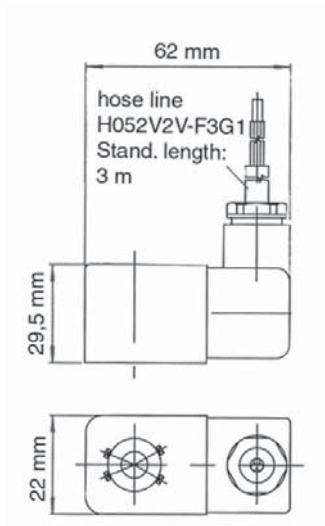

MA 22 EEx m II T4



ATEX approved encapsulated coils for gas and dust explosion-hazardous environment.

System with IEC approval available starting 2014.

The standard cable length is 3 meter, others on request.

Voltage tolerance: -10...+10 %

Relative duty cycle: 100 %

Temperature range: -20°...+50° C

Insulation class of insulating materials according to DIN VDE 0580: F

Protection with mounted plug-in connector according to IEC 529: IP 65

Moulding material: Thermoplasticpolyester

The ATEX approval is only valid as long as the associated components are used.

These coils are approved according to EN 50 028 resp. DIN VDE 0170/0171, part 9 by the Physikalisch-Technische-Bundesanstalt (PTB). For additional information see „Specification for Electronic Devices“ DIN VDE 0580.

Type	Operating press.	Power consumption	Temperature class
MA 22 EEx M II T4 24=	max. 10 bar	5,0 Watt	T4 (135° C)
MA 22 EEx M II T4 110~	max. 10 bar	4,5 VA	T4 (135° C)
MA 22 EEx M II T4 230~	max. 10 bar	5,1 VA	T4 (135° C)

ATEX-approved valves – Ex ia – standard temperature range – aluminium

The following solenoid valves are available:



Material: Aluminum, anodized
 Zone: 1, 2, 21, 22
 Temperature range: -10°C ... +50°C
 Ignition protection type: Ex ia (intrinsically safe)
 Temperature class: T6

Marking on valve

 II2G/D c T6 -10° C ≤ Ta ≤ 50° C

Please notice:

Maximum operating pressure for valves with Ex ia solenoid system is 8 bar!

Coil is 30 mm wide!

Solenoids are described on page 2.12.2.2.5

Delivery contains valve with the appropriate operator system, coil, connector, manual and declaration of conformity.

Type	Function	Port size	Installation	Further inform. on valve on page
MH 210 501 Ex ia	2/2-way, single sol.	G 1/8"	in-line	2.5.1.1.11
MH 210 701 Ex ia	2/2-way, single sol.	G 1/4"	in-line	2.5.1.1.11
MH 311 012 Ex ia	3/2-way direct acting	M5	in-line	2.5.1.1.2
MH 311 015 Ex ia	3/2-way direct acting	G 1/8"	in-line	2.5.1.1.2
MH 310 501 Ex ia	3/2-way, single sol.	G 1/8"	in-line	2.5.1.1.12
MOH 310 501 Ex ia	3/2-way, n.o. single sol.	G 1/8"	in-line	2.5.1.1.12
MH 310 701 Ex ia	3/2-way, single sol.	G 1/4" - 1/4" NPT	in-line	2.5.1.1.12
MOH 310 701 Ex ia	3/2-way, n.o. single sol.	G 1/4" - 1/4" NPT	in-line	2.5.1.1.12
MH 310 801 Ex ia	3/2-way, single sol.	G 1/4"	in-line	2.5.1.1.12
MOH 310 801 Ex ia	3/2-way, n.o. single sol.	G 1/4"	in-line	2.5.1.1.12
MH 310 101 Ex ia	3/2-way, single sol.	G 3/8"	in-line	2.5.1.1.13
MOH 310 101 Ex ia	3/2-way, n.o. single sol.	G 3/8"	in-line	2.5.1.1.13
MH 310 121 Ex ia	3/2-way, single sol.	G 1/2" - 1/2" NPT	in-line	2.5.1.1.13
MOH 310 121 Ex ia	3/2-way, n.o. single sol.	G 1/2" - 1/2" NPT	in-line	2.5.1.1.13
MH 310 101 G Ex ia	3/2-way, single sol.	G 3/8"	dual use*	2.5.1.1.15
MOH 310 101 G Ex ia	3/2-way, n.o. single sol.	G 3/8"	dual use*	2.5.1.1.15
MH 310 121 G Ex ia	3/2-way, single sol.	G 1/2"	dual use*	2.5.1.1.15
MOH 310 121 G Ex ia	3/2-way, n.o. single sol.	G 1/2"	dual use*	2.5.1.1.15
MH 320 501 Ex ia	3/2-way, double sol.	G 1/8"	in-line	2.5.1.1.16
MH 320 701 Ex ia	3/2-way, double sol.	G 1/4"	in-line	2.5.1.1.16
MH 320 801 Ex ia	3/2-way, double sol.	G 1/4"	in-line	2.5.1.1.16
MH 320 101 Ex ia	3/2-way, double sol.	G 3/8"	in-line	2.5.1.1.17
MH 320 121 Ex ia	3/2-way, double sol.	G 1/2" - 1/2" NPT	in-line	2.5.1.1.17
MH 320 121 G Ex ia	3/2-way, double sol.	G 1/2"	dual use*	2.5.1.1.18
MH 510 501 Ex ia	5/2-way, single sol.	G 1/8"	in-line	2.5.2.1.3
MH 510 701 Ex ia	5/2-way, single sol.	G 1/4" - 1/4" NPT	in-line	2.5.2.1.3
MH 510 801 Ex ia	5/2-way, single sol.	G 1/4"	in-line	2.5.2.1.3
MH 510 101 Ex ia	5/2-way, single sol.	G 3/8"	in-line	2.5.2.1.4
MH 510 121 Ex ia	5/2-way, single sol.	G 1/2" - 1/2" NPT	in-line	2.5.2.1.4
MH 510 101 G Ex ia	5/2-way, single sol.	G 3/8"	dual use*	2.5.2.1.6
MH 510 121 G Ex ia	5/2-way, single sol.	G 1/2"	dual use*	2.5.2.1.6
MH 520 501 Ex ia	5/2-way, double sol.	G 1/8"	in-line	2.5.2.1.9
MH 520 701 Ex ia	5/2-way, double sol.	G 1/4" - 1/4" NPT	in-line	2.5.2.1.9
MH 520 801 Ex ia	5/2-way, double sol.	G 1/4"	in-line	2.5.2.1.9
MH 520 101 Ex ia	5/2-way, double sol.	G 3/8"	in-line	2.5.2.1.10
MH 520 121 Ex ia	5/2-way, double sol.	G 1/2" - 1/2" NPT	in-line	2.5.2.1.10
MH 520 101 G Ex ia	5/2-way, double sol.	G 3/8"	dual use*	2.5.2.1.12
MH 520 121 G Ex ia	5/2-way, double sol.	G 1/2"	dual use*	2.5.2.1.12
MH 53_ 501 Ex ia	5/3-way, different versions	G 1/8"	in-line	2.5.3.1.2
MH 53_ 701 Ex ia	5/3-way, different versions	G 1/4" - 1/4" NPT	in-line	2.5.3.1.2
MH 53_ 801 Ex ia	5/3-way, different versions	G 1/4"	in-line	2.5.3.1.2
MH 53_ 101 Ex ia	5/3-way, different versions	G 3/8"	in-line	2.5.3.1.3
MH 53_ 121 Ex ia	5/3-way, different versions	G 1/2" - 1/2" NPT	in-line	2.5.3.1.3
MH 53_ 101 G Ex ia	5/3-way, different versions	G 3/8"	dual use*	2.5.3.1.5
MH 53_ 121 G Ex ia	5/3-way, different versions	G 1/2"	dual use*	2.5.3.1.5

Valves with interface according to Namur standard

MNH 350 701 Ex ia	3/2-way & 5/2-way	G 1/4" - 1/4" NPT	1/4" Namur	2.8.1.3
MNH 310 701 Ex ia	3/2-way, single sol.	G 1/4" - 1/4" NPT	1/4" Namur	2.8.1.1.1
MNH 310 711 Ex ia	3/2-way, single sol.	G 1/4"	1/4" Namur	2.8.1.1.1
MNH 310 121 Ex ia	3/2-way, single sol.	G 1/2" - 1/2" NPT	1/2" Namur	2.8.1.1.2
MNH 510 701 Ex ia	5/2-way, single sol.	G 1/4" - 1/4" NPT	1/4" Namur	2.8.1.2.1
MNH 510 711 Ex ia	5/2-way, single sol.	G 1/4"	1/4" Namur	2.8.1.2.1
MNH 510 121 Ex ia	5/2-way, single sol.	G 1/2" - 1/2" NPT	1/2" Namur	2.8.1.2.2
MNH 520 701 Ex ia	5/2-way, double sol.	G 1/4" - 1/4" NPT	1/4" Namur	2.8.1.2.3
MNH 520 121 Ex ia	5/2-way, double sol.	G 1/2" - 1/2" NPT	1/2" Namur	2.8.1.2.3
MNH 53_ 701 Ex ia	5/3-way, different versions	G 1/4" - 1/4" NPT	1/4" Namur	2.8.1.4
MNH 53_ 121 Ex ia	5/3-way, centre closed	G 1/2" - 1/2" NPT	1/2" Namur	2.8.1.4

* dual use valves can either be used in-line or on a manifold plate.

ATEX-approved valves – Ex ia – low temperature range – aluminum



Material: Aluminum, anodized
 Zone: 1, 2, 21, 22
 Temperature range: -40°C ... +50°C ❄️
 Ignition protection type: Ex ia (intrinsically safe)
 Temperature class: T6

Marking on valve  II2G/D c T6 -40° C ≤ Ta ≤ 50° C

Please notice:
 Maximum operating pressure for valves with Ex ia solenoid system is 8 bar!

Coil is 30 mm wide!

The following solenoid valves are available:

Type	Function	Port size	Installation	Further information on valve on page
MH 311 012 TT Ex ia	3/2-way direct acting	M5	in-line	2.9.4.1.1
MH 311 015 TT Ex ia	3/2-way direct acting	G 1/8"	in-line	2.9.4.1.1
MH 310 501 TT Ex ia	3/2-way, single sol.	G 1/8"	in-line	2.9.4.1.2
MOH 310 501 TT Ex ia	3/2-way, n.o. single sol.	G 1/8"	in-line	2.9.4.1.2
MH 310 701 GTT Ex ia	3/2-way, single sol.	G 1/4"-1/4" NPT	dual use*	2.9.4.1.2
MOH 310 701 GTT Ex ia	3/2-way, n.o. single sol.	G 1/4"-1/4" NPT	dual use*	2.9.4.1.2
MH 320 501 TT Ex ia	3/2-way, double sol.	G 1/8"	in-line	2.9.4.1.2
MH 320 701 GTT Ex ia	3/2-way, double sol.	G 1/4"	dual use*	2.9.4.1.2
MH 510 501 GTT Ex ia	5/2-way, single sol.	G 1/8"	dual use*	2.9.4.2.1
MH 510 701 GTT Ex ia	5/2-way, single sol.	G 1/4"-1/4" NPT	dual use*	2.9.4.2.1
MH 520 501 GTT Ex ia	5/2-way, double sol.	G 1/8"	dual use*	2.9.4.2.2
MH 520 701 GTT Ex ia	5/2-way, double sol.	G 1/4"-1/4" NPT	dual use*	2.9.4.2.2
MH 53_501 GTT Ex ia	5/3-way, different versions	G 1/8"	dual use*	2.9.4.2.2
MH 53_701 GTT Ex ia	5/3-way, different versions	G 1/4"-1/4" NPT	dual use*	2.9.4.2.2

Valves with interface according to Namur standard

MNH 310 701 TT Ex ia	3/2-way, single sol.	G 1/4"-1/4" NPT	1/4" Namur	2.9.5.1
MNH 510 701 TT Ex ia	5/2-way, single sol.	G 1/4"-1/4" NPT	1/4" Namur	2.9.5.2.1
MNH 510 711 TT Ex ia	5/2-way, single sol.	G 1/4"	1/4" Namur	2.9.5.2.1
MNH 520 701 TT Ex ia	5/2-way, double sol.	G 1/4"-1/4" NPT	1/4" Namur	2.9.5.2.2
MNH 531 701 TT Ex ia	5/3-way, centre closed	G 1/4"-1/4" NPT	1/4" Namur	2.9.5.2.2

* dual use valves can either be used in-line or on a manifold plate.

Solenoids are described on page 2.12.2.2.5

Delivery contains valve with the appropriate operator system, coil, manual and declaration of conformity.

ATEX-approved valves – Ex ia – standard temperature range – stainless steel



Material: Stainless steel, 316L 
 Zone: 1, 2, 21, 22
 Temperature range: -10°C ... +50°C
 Ignition protection type: Ex ia (intrinsically safe)
 Temperature class: T6

Marking on valve  II2G/D c T6 -10° C ≤ Ta ≤ 50° C

Please notice:
 Maximum operating pressure for valves with Ex ia solenoid system is 8 bar!

Coil is 30 mm wide!

The following **solenoid valves** are available:

Type	Function	Port size	Installation	Further information on valve on page
MH 311 015 VES Ex ia	3/2-way direct acting	G 1/8"	in-line	2.10.3.1
MH 310 701 VES Ex ia	3/2-way, single sol.	G 1/4" - 1/4" NPT	in-line	2.10.3.2
MOH 310 701 VES Ex ia	3/2-way, n.o. single sol.	G 1/4" - 1/4" NPT	in-line	2.10.3.2
MH 310 121 VES Ex ia	3/2-way, single sol.	G 1/2"	in-line	2.10.3.3
MH 320 121 VES Ex ia	3/2-way, double sol.	G 1/2"	in-line	2.10.3.3
MH 510 701 VES Ex ia	5/2-way, single sol.	G 1/4" - 1/4" NPT	in-line	2.10.3.4
MH 510 121 VES Ex ia	5/2-way, single sol.	G 1/2" - 1/2" NPT	in-line	2.10.3.4
MH 520 701 VES Ex ia	5/2-way, double sol.	G 1/4" - 1/4" NPT	in-line	2.10.3.5
MH 520 121 VES Ex ia	5/2-way, double sol.	G 1/2" - 1/2" NPT	in-line	2.10.3.5
MH 53_701 VES Ex ia	5/3-way, different versions	G 1/4" - 1/4" NPT	in-line	2.10.3.6
MH 53_121 VES Ex ia	5/3-way, different versions	G 1/2" - 1/2" NPT	in-line	2.10.3.6

Valves with interface according to Namur standard

MNH 350 701 VES Ex ia	3/2-way & 5/2-way	G 1/4" - 1/4" NPT	1/4" Namur	2.10.4.3
MNH 310 701 VES Ex ia	3/2-way, single sol.	G 1/4" - 1/4" NPT	1/4" Namur	2.10.4.1
MNH 510 701 VES Ex ia	5/2-way, single sol.	G 1/4" - 1/4" NPT	1/4" Namur	2.10.4.2
MNH 520 701 VES Ex ia	5/2-way, double sol.	G 1/4" - 1/4" NPT	1/4" Namur	2.10.4.2



* dual use valves can either be used in-line or on a manifold plate.

Solenoids are described on page 2.12.2.2.5

Delivery contains valve with the appropriate operator system, coil, manual and declaration of conformity.

ATEX-approved valves – Ex ia – low temperature range – stainless steel



Material: Stainless steel, 316L 
 Zone: 1, 2, 21, 22
 Temperature range: -40°C ... +50°C 
 Ignition protection type: Ex ia (intrinsically safe)
 Temperature class: T6

Marking on valve  II2G/D c T6 -40° C ≤ Ta ≤ 50° C

Please notice:
 Maximum operating pressure for valves with Ex ia
 solenoid system is 8 bar!

The following solenoid valves are available:

Type	Function	Port size	Installation	Further information on valve on page
MH 311 015 VES TT Ex ia	3/2-way direct acting	G 1/8"	in-line	2.10.3.1
MH 310 701 VES TT Ex ia	3/2-way, single sol.	G 1/4" - 1/4" NPT	in-line	2.10.3.2
MOH 310 701 VES TT Ex ia	3/2-way, n.o. single sol.	G 1/4" - 1/4" NPT	in-line	2.10.3.2
MH 510 701 VES TT Ex ia	5/2-way, single sol.	G 1/4" - 1/4" NPT	in-line	2.10.3.4
MH 520 701 VES TT Ex ia	5/2-way, double sol.	G 1/4" - 1/4" NPT	in-line	2.10.3.5
MH 53_701 VES TT Ex ia	5/3-way, different versions	G 1/4" - 1/4" NPT	in-line	2.10.3.6
Valves with interface according to Namur standard				
MNH 350 701 VES TT Ex ia	3/2-way & 5/2-way	G 1/4" - 1/4" NPT	1/4" Namur	2.10.4.3
MNH 310 701 VES TT Ex ia	3/2-way, single sol.	G 1/4" - 1/4" NPT	1/4" Namur	2.10.4.1
MNH 510 701 VES TT Ex ia	5/2-way, single sol.	G 1/4" - 1/4" NPT	1/4" Namur	2.10.4.2
MNH 520 701 VES TT Ex ia	5/2-way, double sol.	G 1/4" - 1/4" NPT	1/4" Namur	2.10.4.2

* dual use valves can either be used in-line or on a manifold plate.

Solenoids are described on page 2.12.2.2.4

Delivery contains valve with the appropriate operator
 system, coil, manual and declaration of conformity.

MA 30 Ex ia tD II CT6 24 DC

When this solenoid system is used in combination with „ATEX certified“ mechanical components conforming EN 13463-1:2001 and PrEN 13463-5:2000, the entire valve can be used in explosive hazardous environment zone 1 and 21.



ATEX approved intrinsic safety coil and connector for gas and dust explosion-hazardous environment. System is also IEC approved. Electrical connection according to DIN EN 175301-803-A / ISO 4400.

Coil:

Electrical characteristics:	21,6... 28 V DC >37 mA final temperature rise 18 K 275 Ohm +/-8 %
Relative duty cycle:	100 %
Temperature range:	-40° ... +50° C
Insulation class of insulating materials according to DIN VDE 0580:	F
Protection with connector according to EN 60529:	IP 65
Moulding material:	Epoxy

Barrier:

Electrical characteristics:	21,6... 28 V DC
Admissible peak value:	28 V DC 115 mA 1,6 W

Order Code: MA 30 Ex ia tD II CT6 24 DC

As the coil is 30 mm wide, a spacer plate called „ZPN 5“ has to be used, in case of combination with our Namur valve series 700 refer to page 2.8.4.11.

ST 30 Ex ia is an ATEX approved connector, especially designed for being used in combination with the intrinsic safety coil. For dust approval (zone 21), this original connector has to be used.

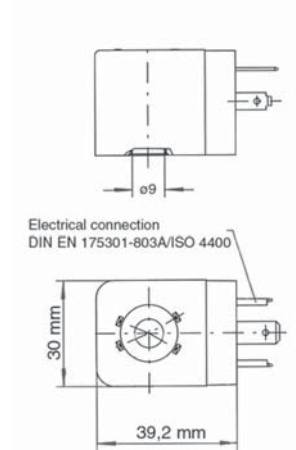

MA 30 Ex ia tD II CT6 24 DC

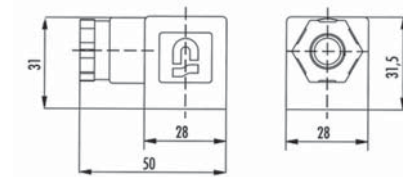

ST 30 Ex ia

Delivery includes connector ST 30 Ex ia, flat nitril gasket and fixing screw (zinc-plated steel). Form according to A - ISO 4400, no LED, no varistor, operating voltage 0 – 250 V, max. current 10 A, cable diameter 6 – 8 mm.

The ATEX approval is only valid as long as the associated components are used. These coils are approved according to EN 50 020 resp. DIN VDE 0170/0171, part 5 by the Physikalisch-Technische-Bundesanstalt (PTB). For additional information see „Specification for Electronic Devices“ DIN VDE 0580.

ATEX-approved valves – Ex nA – standard temperature range – aluminum



Material: Aluminum, anodized, head PA
Zone: 2, 22
Temperature range: -10°C ... +50°C
Ignition protection type: Ex nA (non-sparking)
Temperature class: T5

Marking on valve Ex II2G/D c T4 -10° C ≤ Ta ≤ 50° C
II3G/D c T5 -10° C ≤ Ta ≤ 50° C

The following solenoid valves are available:

Type	Function	Port size	Installation	Further inform. on valve	Type	Function	Port size	Installation	Further inform. on valve
MH 210 501 Ex nA	2/2-way, single sol.	G 1/8"	in-line	2.5.1.1.11	MH 520 101 Ex nA	5/2-way, double sol.	G 3/8"	in-line	2.5.2.1.10
MH 210 701 Ex nA	2/2-way, single sol.	G 1/4"	in-line	2.5.1.1.11	MH 520 121 Ex nA	5/2-way, double sol.	G 1/2" - NPT	in-line	2.5.2.1.10
MH 311 012 Ex nA	3/2-way direct acting	M5	in-line	2.5.1.1.2	MH 520 501 G Ex nA	5/2-way, double sol.	G 1/8"	dual use*	2.5.2.1.11
MH 311 015 Ex nA	3/2-way direct acting	G 1/8"	in-line	2.5.1.1.2	MH 520 701 G Ex nA	5/2-way, double sol.	G 1/4" - NPT	dual use*	2.5.2.1.11
MH 311 013 Ex nA	3/2-way direct acting	G 1/8"	banjo screw	2.5.1.1.4	MH 520 101 G Ex nA	5/2-way, double sol.	G 3/8"	dual use*	2.5.2.1.12
MH 311 017 Ex nA	3/2-way direct acting	G 1/4"	banjo screw	2.5.1.1.4	MH 520 121 G Ex nA	5/2-way, double sol.	G 1/2"	dual use*	2.5.2.1.12
MH 312 Ex nA	3/2-way direct acting	M5	manifold	2.5.1.2.2	MH 520 504 Ex nA	5/2-way, double sol.	5 mm orifice	manifold	2.5.2.2.8
MH 315 Ex nA	3/2-way direct acting	G 1/8"	manifold	2.5.1.2.2	MH 520 704 Ex nA	5/2-way, double sol.	7 mm orifice	manifold	2.5.2.2.8
MH 310 501 Ex nA	3/2-way, single sol.	G 1/8"	in-line	2.5.1.1.12	MH 53_501 Ex nA	5/3-way, different versions	G 1/8"	in-line	2.5.3.1.2
MOH 310 501 Ex nA	3/2-way, n.o. single sol.	G 1/8"	in-line	2.5.1.1.12	MH 53_701 Ex nA	5/3-way, different versions	G 1/4"	in-line	2.5.3.1.2
MH 310 701 Ex nA	3/2-way, single sol.	G 1/4"	in-line	2.5.1.1.12	MH 53_801 Ex nA	5/3-way, different versions	G 1/4"	in-line	2.5.3.1.2
MOH 310 701 Ex nA	3/2-way, n.o. single sol.	G 1/4"	in-line	2.5.1.1.12	MH 53_101 Ex nA	5/3-way, different versions	G 3/8"	in-line	2.5.3.1.3
MH 310 801 Ex nA	3/2-way, single sol.	G 1/4"	in-line	2.5.1.1.12	MH 53_121 Ex nA	5/3-way, different versions	G 1/2" - NPT	in-line	2.5.3.1.3
MOH 310 801 Ex nA	3/2-way, n.o. single sol.	G 1/4"	in-line	2.5.1.1.12	MH 53_501 G Ex nA	5/3-way, different versions	G 1/8"	dual use*	2.5.3.1.4
MH 310 101 Ex nA	3/2-way, single sol.	G 3/8"	in-line	2.5.1.1.13	MH 53_701 G Ex nA	5/3-way, different versions	G 1/4" - NPT	dual use*	2.5.3.1.4
MOH 310 101 Ex nA	3/2-way, n.o. single sol.	G 3/8"	in-line	2.5.1.1.13	MH 53_101 G Ex nA	5/3-way, different versions	G 3/8"	dual use*	2.5.3.1.5
MH 310 121 Ex nA	3/2-way, single sol.	G 1/2" - NPT	in-line	2.5.1.1.13	MH 53_121 G Ex nA	5/3-way, different versions	G 1/2"	dual use*	2.5.3.1.5
MOH 310 121 Ex nA	3/2-way, n.o. single sol.	G 1/2" - NPT	in-line	2.5.1.1.13	MH 53_504 Ex nA	5/3-way, different versions	5 mm orifice	manifold	2.5.3.2.4
MH 310 501 G Ex nA	3/2-way, single sol.	G 1/8"	dual use*	2.5.1.1.14	MH 53_704 Ex nA	5/3-way, different versions	7 mm orifice	manifold	2.5.3.2.4
MOH 310 501 G Ex nA	3/2-way, n.o. single sol.	G 1/8"	dual use*	2.5.1.1.14					
MH 310 701 G Ex nA	3/2-way, single sol.	G 1/4" - NPT	dual use*	2.5.1.1.14					
MOH 310 701 G Ex nA	3/2-way, n.o. single sol.	G 1/4" - NPT	dual use*	2.5.1.1.14					
MH 310 101 G Ex nA	3/2-way, single sol.	G 3/8"	dual use*	2.5.1.1.14					
MOH 310 101 G Ex nA	3/2-way, n.o. single sol.	G 3/8"	dual use*	2.5.1.1.15					
MH 310 121 G Ex nA	3/2-way, single sol.	G 1/2"	dual use*	2.5.1.1.15					
MOH 310 121 G Ex nA	3/2-way, n.o. single sol.	G 1/2"	dual use*	2.5.1.1.15					
MH 320 501 Ex nA	3/2-way, double sol.	G 1/8"	in-line	2.5.1.1.16					
MH 320 701 Ex nA	3/2-way, double sol.	G 1/4"	in-line	2.5.1.1.16					
MH 320 801 Ex nA	3/2-way, double sol.	G 1/4"	in-line	2.5.1.1.16					
MH 320 101 Ex nA	3/2-way, double sol.	G 3/8"	in-line	2.5.1.1.17					
MH 320 121 Ex nA	3/2-way, double sol.	G 1/2"	in-line	2.5.1.1.17					
MH 320 501 G Ex nA	3/2-way, double sol.	G 1/8"	dual use*	2.5.1.1.18					
MH 320 701 G Ex nA	3/2-way, double sol.	G 1/4"	dual use*	2.5.1.1.18					
MH 320 121 G Ex nA	3/2-way, double sol.	G 1/2"	dual use*	2.5.1.1.18					
MH 510 501 Ex nA	5/2-way, single sol.	G 1/8"	in-line	2.5.2.1.3					
MH 510 701 Ex nA	5/2-way, single sol.	G 1/4"	in-line	2.5.2.1.3					
MH 510 801 Ex nA	5/2-way, single sol.	G 1/4"	in-line	2.5.2.1.3					
MH 510 101 Ex nA	5/2-way, single sol.	G 3/8"	in-line	2.5.2.1.4					
MH 510 121 Ex nA	5/2-way, single sol.	G 1/2" - NPT	in-line	2.5.2.1.4					
MH 510 501 G Ex nA	5/2-way, single sol.	G 1/8"	dual use*	2.5.2.1.5					
MH 510 701 G Ex nA	5/2-way, single sol.	G 1/4" - NPT	dual use*	2.5.2.1.5					
MH 510 101 G Ex nA	5/2-way, single sol.	G 3/8"	dual use*	2.5.2.1.6					
MH 510 121 G Ex nA	5/2-way, single sol.	G 1/2"	dual use*	2.5.2.1.6					
MH 510 504 Ex nA	5/2-way, single sol.	5 mm orifice	manifold	2.5.2.2.4					
MH 510 704 Ex nA	5/2-way, single sol.	7 mm orifice	manifold	2.5.2.2.4					
MH 520 501 Ex nA	5/2-way, double sol.	G 1/8"	in-line	2.5.2.1.9					
MH 520 701 Ex nA	5/2-way, double sol.	G 1/4"	in-line	2.5.2.1.9					
MH 520 801 Ex nA	5/2-way, double sol.	G 1/4"	in-line	2.5.2.1.9					

Valves with interface according to Namur standard				
MNH 350 701 Ex nA	3/2-way & 5/2-way	G 1/4" - NPT	1/4" Namur	2.8.1.3
MNH 310 701 Ex nA	3/2-way, single sol.	G 1/4" - NPT	1/4" Namur	2.8.1.1.1
MNH 310 711 Ex nA	3/2-way, single sol.	G 1/4"	1/4" Namur	2.8.1.1.1
MNH 310 121 Ex nA	3/2-way, single sol.	G 1/2" - NPT	1/2" Namur	2.8.1.1.2
MNH 510 701 Ex nA	5/2-way, single sol.	G 1/4" - NPT	1/4" Namur	2.8.1.2.1
MNH 510 711 Ex nA	5/2-way, single sol.	G 1/4"	1/4" Namur	2.8.1.2.1
MNH 510 121 Ex nA	5/2-way, single sol.	G 1/2" - NPT	1/2" Namur	2.8.1.2.2
MNH 520 701 Ex nA	5/2-way, double sol.	G 1/4" - NPT	1/4" Namur	2.8.1.2.3
MNH 520 121 Ex nA	5/2-way, double sol.	G 1/2" - NPT	1/2" Namur	2.8.1.2.3
MNH 53_701 Ex nA	5/3-way, different versions	G 1/4" - NPT	1/4" Namur	2.8.1.4
MNH 531 121 Ex nA	5/3-way, centre closed	G 1/2" - NPT	1/2" Namur	2.8.1.4

* dual use valves can either be used in-line or on a manifold plate.

Solenoids are described on page 2.12.2.2.5

Delivery contains valve with the appropriate operator system, coil, manual and declaration of conformity.

ATEX-approved valves – Ex nA – standard temperature range – stainless steel



Material: Stainless steel, 316L 
 Zone: 2, 22
 Temperature range: -10°C ... +50°C
 Ignition protection type: Ex nA (non-sparking)
 Temperature class: T5

Marking on valve  II2G/D c T4 -10° C ≤ Ta ≤ 50° C
 II3G/D c T5 -10° C ≤ Ta ≤ 50° C

The following solenoid valves are available:

Type	Function	Port size	Installation	Further information on valve on page
MH 311 015 VES Ex nA	3/2-way direct acting	G 1/8"	in-line	2.10.3.1
MH 310 701 VES Ex nA	3/2-way, single sol.	G 1/4" - 1/4" NPT	in-line	2.10.3.2
MOH 310 701 VES Ex nA	3/2-way, n.o. single sol.	G 1/4" - 1/4" NPT	in-line	2.10.3.2
MH 310 121 VES Ex nA	3/2-way, single sol.	G 1/2" - 1/2" NPT	in-line	2.10.3.3
MH 320 121 VES Ex nA	3/2-way, double sol.	G 1/2"	in-line	2.10.3.3
MH 510 701 VES Ex nA	5/2-way, single sol.	G 1/4" - 1/4" NPT	in-line	2.10.3.4
MH 510 121 VES Ex nA	5/2-way, single sol.	G 1/2" - 1/2" NPT	in-line	2.10.3.4
MH 520 701 VES Ex nA	5/2-way, double sol.	G 1/4" - 1/4" NPT	in-line	2.10.3.5
MH 520 121 VES Ex nA	5/2-way, double sol.	G 1/2" - 1/2" NPT	in-line	2.10.3.5
MH 53_701 VES Ex nA	5/3-way, different versions	G 1/4" - 1/4" NPT	in-line	2.10.3.6
MH 53_121 VES Ex nA	5/3-way, different versions	G 1/2" - 1/2" NPT	in-line	2.10.3.6

Valves with interface according to Namur standard

MNH 350 701 VES Ex nA	3/2-way & 5/2-way	G 1/4" - 1/4" NPT	1/4" Namur	2.10.4.3
MNH 310 701 VES Ex nA	3/2-way, single sol.	G 1/4" - 1/4" NPT	1/4" Namur	2.10.4.1
MNH 510 701 VES Ex nA	5/2-way, single sol.	G 1/4" - 1/4" NPT	1/4" Namur	2.10.4.2
MNH 520 701 VES Ex nA	5/2-way, double sol.	G 1/4" - 1/4" NPT	1/4" Namur	2.10.4.2

* dual use valves can either be used in-line or on a manifold plate.

Solenoids are described on page 2.12.2.3.3

Delivery contains valve with the appropriate operator system, coil, manual and declaration of conformity.

When this solenoid system is used in combination with "ATEX certified" mechanical components conforming EN 13463-1:2001 and PrEN 13463-5:2000, the entire valve can be used in explosive hazardous environment zone 2 and 22.

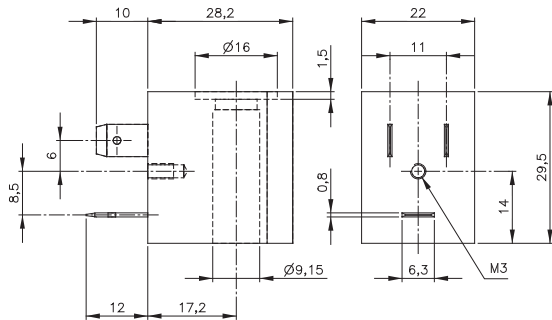

MA 22 EEx nA T5 24DC

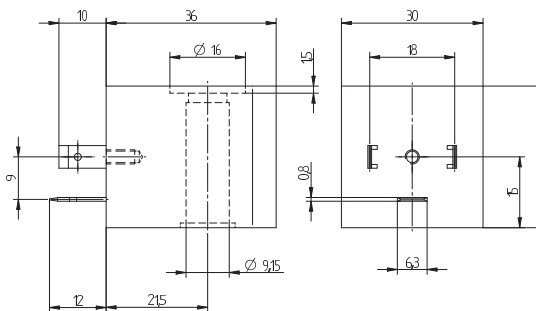

MA 30 EEx nA T5 24DC



ATEX approved non-sparking coil for gas and dust explosion-hazardous environment.

Coil:

Voltage tolerance: 24 V DC +/- 10 %

Relative duty cycle: 100 %

Temperature range: -15°... +50° C

Insulation class of insulating materials according to DIN VDE 0580: F

Protection with connector according to EN 60529: IP 65

Moulding material: Termoplastico polyester

Delivery content without ATEX approved connector.

30 mm wide ATEX connector available, type ST 30 Ex nA (page 2.11.3).

22 mm wide ATEX connector available on request.

Type	Operating press.	Power cons.	Temp. class	Connection
MA 22 EEx nA T5 24DC	max. 10 bar	3,0 Watt	T5 (100° C)	Industryform B (DW 436 50)
MA 30 EEx nA T5 24DC	max. 10 bar	2,0 Watt	T5 (100° C)	Form A (ISO 440)

Other voltages are available on request.

ATEX-approved valves – Ex e mb – standard temperature range – aluminum



Material: Aluminum, anodized
 Zone: 1, 2, 21, 22
 Temperature range: -10°C ... +50°C
 Ignition protection type: Ex e mb (encapsulation with junction box)
 Temperature class: T6

Marking on valve  II2G/D c T6 -10° C ≤ Ta ≤ 50° C

The following solenoid valves are available:

Type	Function	Port size	Installation	Further information on valve on page
MH 310 501 Ex e mb	3/2-way, single sol.	G 1/8"	in-line	2.5.1.1.12
MOH 310 501 Ex e mb	3/2-way, n.o. single sol.	G 1/8"	in-line	2.5.1.1.12
MH 310 701 Ex e mb	3/2-way, single sol.	G 1/4" -1/4" NPT	in-line	2.5.1.1.12
MOH 310 701 Ex e mb	3/2-way, n.o. single sol.	G 1/4" -1/4" NPT	in-line	2.5.1.1.12
MH 310 801 Ex e mb	3/2-way, single sol.	G 1/4"	in-line	2.5.1.1.12
MOH 310 801 Ex e mb	3/2-way, n.o. single sol.	G 1/4"	in-line	2.5.1.1.12
MH 310 101 Ex e mb	3/2-way, single sol.	G 3/8"	in-line	2.5.1.1.13
MOH 310 101 Ex e mb	3/2-way, n.o. single sol.	G 3/8"	in-line	2.5.1.1.13
MH 310 121 Ex e mb	3/2-way, single sol.	G 1/2" -1/2" NPT	in-line	2.5.1.1.13
MOH 310 121 Ex e mb	3/2-way, n.o. single sol.	G 1/2" -1/2" NPT	in-line	2.5.1.1.13
MH 320 501 Ex e mb	3/2-way, double sol.	G 1/8"	in-line	2.5.1.1.16
MH 320 701 Ex e mb	3/2-way, double sol.	G 1/4"	in-line	2.5.1.1.16
MH 320 801 Ex e mb	3/2-way, double sol.	G 1/4"	in-line	2.5.1.1.16
MH 320 101 Ex e mb	3/2-way, double sol.	G 3/8"	in-line	2.5.1.1.17
MH 320 121 Ex e mb	3/2-way, double sol.	G 1/2"	in-line	2.5.1.1.17
MH 510 501 Ex e mb	5/2-way, single sol.	G 1/8"	in-line	2.5.2.1.3
MH 510 701 Ex e mb	5/2-way, single sol.	G 1/4" -1/4" NPT	in-line	2.5.2.1.3
MH 510 801 Ex e mb	5/2-way, single sol.	G 1/4"	in-line	2.5.2.1.3
MH 510 101 Ex e mb	5/2-way, single sol.	G 3/8"	in-line	2.5.2.1.4
MH 510 121 Ex e mb	5/2-way, single sol.	G 1/2" -1/2" NPT	in-line	2.5.2.1.4
MH 520 501 Ex e mb	5/2-way, double sol.	G 1/8"	in-line	2.5.2.1.9
MH 520 701 Ex e mb	5/2-way, double sol.	G 1/4" -1/4" NPT	in-line	2.5.2.1.9
MH 520 801 Ex e mb	5/2-way, double sol.	G 1/4"	in-line	2.5.2.1.9
MH 520 101 Ex e mb	5/2-way, double sol.	G 3/8"	in-line	2.5.2.1.10
MH 520 121 Ex e mb	5/2-way, double sol.	G 1/2" -1/2" NPT	in-line	2.5.2.1.10
MH 53_501 Ex e mb	5/3-way, different versions	G 1/8"	in-line	2.5.3.1.2
MH 53_701 Ex e mb	5/3-way, different versions	G 1/4" -1/4" NPT	in-line	2.5.3.1.2
MH 53_801 Ex e mb	5/3-way, different versions	G 1/4"	in-line	2.5.3.1.2
MH 53_101 Ex e mb	5/3-way, different versions	G 3/8"	in-line	2.5.3.1.3
MH 53_121 Ex e mb	5/3-way, different versions	G 1/2" -1/2" NPT	in-line	2.5.3.1.3

Valves with interface according to Namur standard

MNH 350 701 Ex e mb	3/2-way & 5/2-way	G 1/4" -1/4" NPT	1/4" Namur	2.8.1.3
MNH 310 701 Ex e mb	3/2-way, single sol.	G 1/4" -1/4" NPT	1/4" Namur	2.8.1.1.1
MNH 310 711 Ex e mb	3/2-way, single sol.	G 1/4"	1/4" Namur	2.8.1.1.1
MNH 310 121 Ex e mb	3/2-way, single sol.	G 1/2" -1/2" NPT	1/2" Namur	2.8.1.1.2
MNH 510 701 Ex e mb	5/2-way, single sol.	G 1/4" -1/4" NPT	1/4" Namur	2.8.1.2.1
MNH 510 711 Ex e mb	5/2-way, single sol.	G 1/4"	1/4" Namur	2.8.1.2.1
MNH 510 121 Ex e mb	5/2-way, single sol.	G 1/2" -1/2" NPT	1/2" Namur	2.8.1.2.2
MNH 520 701 Ex e mb	5/2-way, double sol.	G 1/4" -1/4" NPT	1/4" Namur	2.8.1.2.3
MNH 520 121 Ex e mb	5/2-way, double sol.	G 1/2" -1/2" NPT	1/2" Namur	2.8.1.2.3
MNH 53_701 Ex e mb	5/3-way, different versions	G 1/4" -1/4" NPT	1/4" Namur	2.8.1.4
MNH 531 121 Ex e mb	5/3-way, centre closed	G 1/2" -1/2" NPT	1/2" Namur	2.8.1.4

Solenoids are described on page 2.12.2.4.4

Delivery contains valve with the appropriate operator system, coil, manual and declaration of conformity.

ATEX-approved valves – Ex e mb – low temperature range – aluminum



Material: Aluminum, anodized
 Zone: 1, 2, 21, 22
 Temperature range: -40°C ... +50°C ❄️
 Ignition protection type: Ex e mb (encapsulation with junction box)
 Temperature class: T6

Marking on valve  II2G/D c T6 -40° C ≤ Ta ≤ 50° C

The following solenoid valves are available:

Type	Function	Port size	Installation	Further information on valve on page
MH 310 501 TT Ex e mb	3/2-way, single sol.	G 1/8"	in-line	2.9.4.1.2
MOH 310 501 TT Ex e mb	3/2-way, n.o. single sol.	G 1/8"	in-line	2.9.4.1.2
MH 310 701 GTT Ex e mb	3/2-way, single sol.	G 1/4" - 1/4" NPT	in-line	2.9.4.1.2
MOH 310 701 GTT Ex e mb	3/2-way, n.o. single sol.	G 1/4" - 1/4" NPT	in-line	2.9.4.1.2
MH 320 501 TT Ex e mb	3/2-way, double sol.	G 1/8"	in-line	2.9.4.1.2
MH 320 701 TT Ex e mb	3/2-way, double sol.	G 1/4"	in-line	2.9.4.1.2
MH 510 501 GTT Ex e mb	5/2-way, single sol.	G 1/8"	in-line	2.9.4.2.1
MH 510 701 GTT Ex e mb	5/2-way, single sol.	G 1/4" - 1/4" NPT	in-line	2.9.4.2.1
MH 520 501 GTT Ex e mb	5/2-way, double sol.	G 1/8"	in-line	2.9.4.2.2
MH 520 701 GTT Ex e mb	5/2-way, double sol.	G 1/4" - 1/4" NPT	in-line	2.9.4.2.2
MH 53_501 GTT Ex e mb	5/3-way, different versions	G 1/8"	in-line	2.9.4.2.2
MH 53_701 GTT Ex e mb	5/3-way, different versions	G 1/4" - 1/4" NPT	in-line	2.9.4.2.2

Valves with interface according to Namur standard

MNH 310 701 TT Ex e mb	3/2-way, single sol.	G 1/4" - 1/4" NPT	1/4" Namur	2.9.5.1
MNH 510 701 TT Ex e mb	5/2-way, single sol.	G 1/4" - 1/4" NPT	1/4" Namur	2.9.5.2.1
MNH 510 711 TT Ex e mb	5/2-way, single sol.	G 1/4"	1/4" Namur	2.9.5.2.1
MNH 520 701 TT Ex e mb	5/2-way, double sol.	G 1/4" - 1/4" NPT	1/4" Namur	2.9.5.2.2
MNH 531 701 TT Ex e mb	5/3-way, centre closed	G 1/4" - 1/4" NPT	1/4" Namur	2.9.5.2.2

Solenoids are described on page 2.12.2.4.4

Delivery contains valve with the appropriate operator system, coil, manual and declaration of conformity.

ATEX-approved valves – Ex e mb – low temperature range – stainless steel



Material: Stainless steel, 316L 
 Zone: 1, 2, 21, 22
 Temperature range: -40°C ... +50°C ❄️
 Ignition protection type: Ex e mb (encapsulation with junction box)
 Temperature class: T6

Marking on valve  II2G/D c T6 -40° C ≤ Ta ≤ 50° C

The following solenoid valves are available:

Type	Function	Port size	Installation	Further information on valve on page
MH 310 701 VES TT Ex e mb	3/2-way, single sol.	G 1/4" - 1/4" NPT	in-line	2.10.3.2
MOH 310 701 VES TT Ex e mb	3/2-way, n.o. single sol.	G 1/4" - 1/4" NPT	in-line	2.10.3.2
MH 510 701 VES TT Ex e mb	5/2-way, single sol.	G 1/4" - 1/4" NPT	in-line	2.10.3.4
MH 520 701 VES TT Ex e mb	5/2-way, double sol.	G 1/4" - 1/4" NPT	in-line	2.10.3.5
MH 53_701 VES TT Ex e mb	5/3-way, different version	G 1/4" - 1/4" NPT	in-line	2.10.3.6

Valves with interface according to Namur standard				
Type	Function	Port size	Installation	Further information on valve on page
MNH 350 701 VES TT Ex e mb	3/2-way & 5/2-way	G 1/4" - 1/4" NPT	1/4" Namur	2.10.4.3
MNH 310 701 VES TT Ex e mb	3/2-way, single sol.	G 1/4" - 1/4" NPT	1/4" Namur	2.10.4.1
MNH 310 711 VES TT Ex e mb	3/2-way, single sol.	G 1/4"	1/4" Namur	2.10.4.1
MNH 510 701 VES TT Ex e mb	5/2-way, single sol.	G 1/4" - 1/4" NPT	1/4" Namur	2.10.4.2
MNH 510 711 VES TT Ex e mb	5/2-way, single sol.	G 1/4"	1/4" Namur	2.10.4.2
MNH 520 701 VES TT Ex e mb	5/2-way, double sol.	G 1/4" - 1/4" NPT	1/4" Namur	2.10.4.2

Solenoids are described on page 2.12.2.4.4

Delivery contains valve with the appropriate operator system, coil, manual and declaration of conformity.
 1/2" stainless steel valves in standard temperature range on request.

When this solenoid system is used in combination with "ATEX certified" mechanical components conforming EN 13463-1:2001 and PrEN 13463-5:2000, the entire valve can be used in explosive hazardous environment zone 1 and 21.

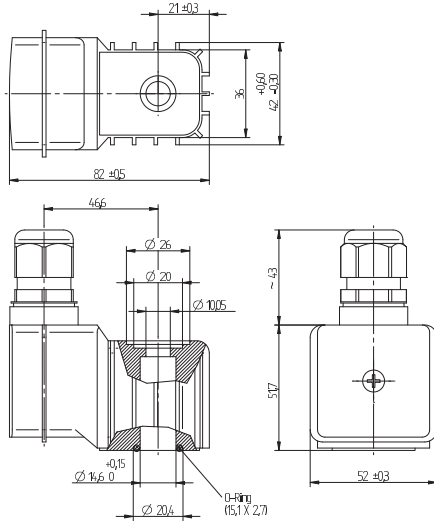

ATEX approved encapsulated coil with junction box for gas and dust explosion-hazardous environment.

Voltage tolerance: - 10...+ 10%

Relative duty cycle: 100 %

Temperature range: -40°C...+50°C

Insulation class of insulating Materials according to DIN VDE 0580: F

Protection according to EN 60529: IP 67

Moulding material: Thermoplasticpolyester

Cable Diameter: 6 – 13 mm

Please notice:
Same coil for 24VDC and 24VAC.

Type	Operating press.	Power cons.	Temperature class
MA 52 EEx e mb IIC T6 24	max. 10 bar	4,8 Watt / 4,3 VA	T6 (85° C)
MA 52 EEx e mb IIC T6 110~	max. 10 bar	4,4 VA	T6 (85° C)
MA 52 EEx e mb IIC T6 230~	max. 10 bar	4,8 VA	T6 (85° C)